

# Lenco

## PORTABLE CD PLAYER WITH USB SCD-37 USB

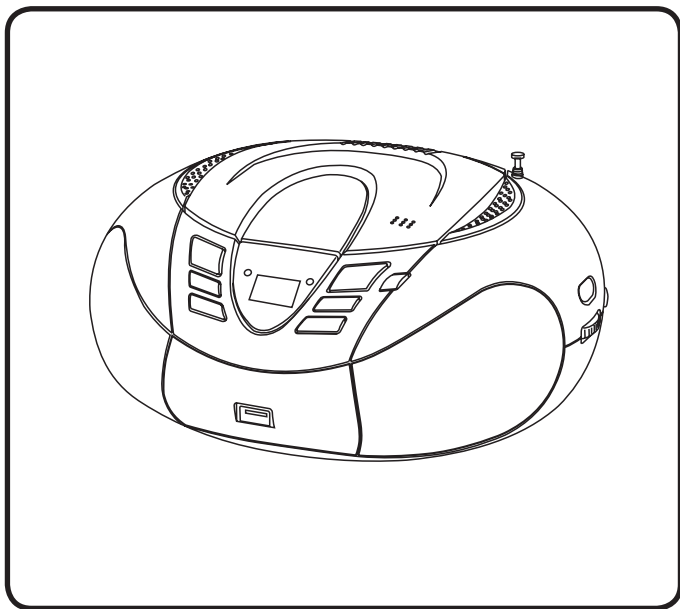

### INSTRUCTION MANUAL

For information and support, [www.lenco.com](http://www.lenco.com)



## WARNING

### CLASS 1 LASER PRODUCT

CLASS 1 LASER PRODUCT  
APPAREIL À LASER DE CLASSE 1  
PRODUCTO LASER DE CLASE 1

CAUTION  
INVISIBLE LASER RADIATION  
WHEN OPEN AND INTERLOCKS  
DEFEATED.  
AVOID EXPOSURE TO BEAM



This product contains a low power laser device.

**Warning: Do not touch the lens.**

**DO NOT THROW BATTERIES IN FIRE !**

## PRECAUTIONS

Follow the advice below for safe and appropriate operations.

### ON PLACEMENT

- Do not use the unit in places which are extremely hot, cold, dusty, or humid.
- Place the unit on a flat and even surface.
- Do not restrict the air flow of the unit by placing it in a place with poor air flow, by covering it with a cloth, or by placing it on a carpet.

### ON SAFETY

- When connecting and disconnecting the AC cord, grip the plug and not the cord itself. Pulling the cord may damage it and create hazard.
- When you are not going to use the unit for a long period of time, disconnect the AC power cord.
- The appliance is not intended for use by persons (including children) with reduced physical, sensory or mental capabilities, or lack of experience and knowledge, unless they have been given supervision or instructions concerning the use of the appliance by a person responsible for their safety.

### ON AC VOLTAGE

- Before use, check that the rated voltage of your unit matches your local voltage.

### ON CONDENSATION

- When left in a heated room where it is warm and damp, water droplets or condensation may form inside the CD player.
- When there is condensation inside the unit, the unit may not function normally.
- Let it stand for 1 to 2 hours before turning the power on, or gradually heat the room up and dry the unit before use.
- Ensure a minimum distance of 5 cm around the apparatus for sufficient ventilation.
- Ensure that the ventilation is not impeded by covering the ventilation openings with items, such as newspapers, table-cloths, curtains, etc..
- Do not place naked flame sources, such as lighted candles on the apparatus.
- Take attention to the environmental aspects of battery disposal.
- Use the apparatus only in moderate climates (not in tropical climates).
- Do not expose the apparatus to dripping or splashing.
- Do not place objects filled with liquids, such as vases, on the apparatus.

**Should any trouble occur, disconnect the AC power cord and refer servicing to qualified personnel.**

"To be completely disconnect the power input, the mains plug of apparatus shall be disconnected from the mains." as the disconnect devices is the mains plug of apparatus.

"The mains plug of apparatus should not be obstructed OR should be easily accessed during intended use."

"Excessive sound pressure from earphones and headphones can cause hearing loss."

"Battery shall not be exposed to excessive heat such as sunshine, fire or the like."



The lightning flash with arrowhead symbol within the triangle is a warning sign alerting the user of "dangerous voltage" inside the unit.

**CAUTION**  
**RISK OF ELECTRIC SHOCK**  
**DO NOT OPEN**

**ATTENTION :** To reduce the risk of electric shock, do not remove the cover. There are no user serviceable parts inside the unit. Refer all servicing to qualified personnel.



The exclamation point within the triangle is a warning sign alerting the user of important instructions accompanying the product.

In case of malfunction due to electrostatic discharge, the apparatus has to be reset by disconnecting it from mains supply.  
**THE MARKING PLATE IS LOCATED AT THE BACK OF ENCLOSURE OF THE APPARATUS**



## LOCATION OF CONTROLS

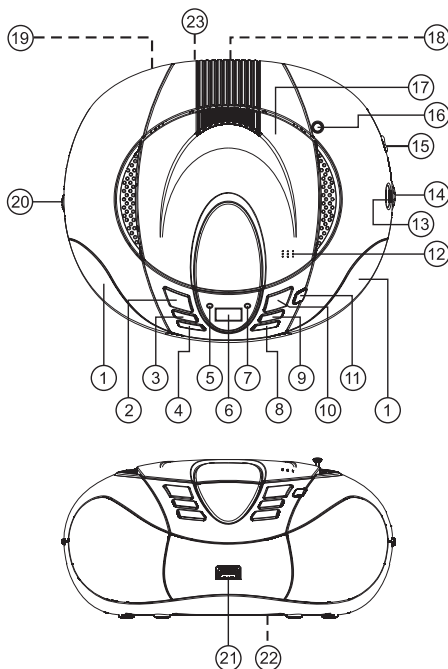

- |   |                          |
|---|--------------------------|
| 1. SPEAKER                                | 12. OPEN/CLOSE CD BUTTON |
| 2. CD FOLDER UP BUTTON                    | 13. DIAL SCALE           |
| 3. CD PREV BUTTON ◀◀                      | 14. TUNING CONTROL       |
| 4. CD NEXT BUTTON ▶▶                      | 15. FUNCTION SELECTOR    |
| 5. POWER INDICATOR                        | 16. TELESCOPIC ANTENNA   |
| 6. LCD DISPLAY                            | 17. CD DOOR              |
| 7. FM STEREO INDICATOR                    | 18. AUX. IN JACK         |
| 8. CD REPEAT BUTTON                       | 19. AC SOCKET            |
| 9. CD PLAY / PAUSE BUTTON ▶▶              | 20. VOLUME CONTROL       |
| 10. CD PROGRAM BUTTON                     | 21. USB PORT             |
| 11. CD STOP ■ / CD/USB ⏏️ BUTTON          | 22. BATTERY COMPARTMENT  |
| (At STOP mode, press to change CD or USB) | 23. HANDLE               |

GB 1

## POWER SUPPLY

### USING HOUSE CURRENT

Before use, check that the rated voltage of your unit matches your local voltage.

Note: Plug is used as the disconnect device.

The disconnect device shall remain readily operable.

### USING BATTERIES

Disconnect the AC power cord from the AC inlet of the unit. Battery power is cut automatically by the cord while it is connected.

battery door

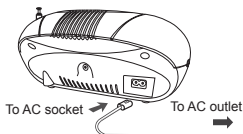
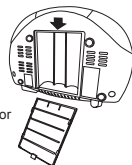

To AC socket

To AC outlet

When the volume decrease, or the sound distorts, replace all of the batteries with new ones.

Insert six UM-2 (size C) batteries.

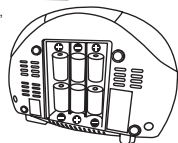

## AUX. IN

An external (auxiliary) audio source (i.e., personal CD player or MP3 player) can be connected to this unit and heard through the speakers.

- 1) Plug one end of cable into the AUX IN socket on the unit.
- 2) Plug the other end of the cable into the Headphone or Line Out socket of the external source.
- 3) Set function switch on the unit to AUX IN.

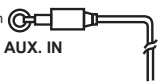

AUX. IN

(Plug other end into external source such as an MP3 player.)

FUNCTION  
AUX IN



Continue to operate CD or MP3 player as usual. Selections will be heard through the unit's speakers.

Unit will be automatically off at about 15 mins without further operation.

After auto off, slide the FUNCTION selector to OFF position and then slide to AUX IN position for listening.

## ADJUSTING THE SOUND

### TO ADJUST THE VOLUME



## LISTENING TO THE RADIO

1. Set to FM

FUNCTION

FM



3. Adjust the sound.

VOLUME

MAX. MIN.



2. Tune in to a station.

TUNING



FOR BETTER RECEPTION

NOTE :  
FM stereo LED indicator lights if receive FM stereo broadcast .

AFTER LISTENING  
Set the FUNCTION selector to OFF.



## COMPACT DISC PLAYBACK

1. Set to CD

### FUNCTION



2. Press the STOP button repeatedly until "Cd" is shown on display.



3. Open the CD door by pushing Open / Close CD button.



4. Insert a disc with the label side facing up.

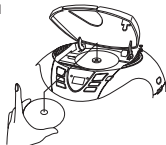

5. Close the CD door. The disc will rotate and 1st track will be played automatically.

6. Track number "01" & the symbol "▶" & "DISC" will be shown during normal compact disc playback. Track number "001", the symbol "▶" & "DISC & MP3" will be shown during MP3 playback.



CD display



MP3 display

### TO INTERRUPT PLAYBACK

Press the Play/Pause button and the symbol "▶" will be flashed. Press the button again to resume playback.



CD display



MP3 display

### TO STOP PLAYBACK

Press the STOP button and the display shows the total tracks of the disc.



### TO SKIP TO THE BEGINNING OF A TRACK

- Press either one of the PREVIOUS or NEXT buttons according to the desired skip direction.
- Play/back resumes from the selected track.
- When the PREVIOUS button is pressed once during play, the current track starts again.
- When the NEXT button is pressed once during play, the next track plays.



### SEARCHING FOR A PASSAGE WITHIN A TRACK

- Keep the PREVIOUS or NEXT button pressed during playback, and release the button as soon as you recognise the desired

Unit will be automatically off at about 15 mins without further operation (in stop mode / CD door open).

After auto off, slide the FUNCTION selector to OFF position and then slide to RADIO / CD position for listening.

## REPEAT , REPEAT FOLDER AND REPEAT ALL PLAYBACK

Press REPEAT button during CD playback. CD plays with a single track repeat, all tracks repeat.





### FOR NORMAL COMPACT DISC PLAYBACK

Mode sequence REPEAT >> REPEAT ALL >> CLEAR.

During Repeat 1 mode, display shows



During Repeat 2 mode, display shows



CD display

### FOR MP3 / USB PLAYBACK

Mode sequence REPEAT >> REPEAT FOLDER >> REPEAT ALL >> CLEAR.

During Repeat 1 mode, display shows



During Repeat 2 mode, display shows



During Repeat 3 mode, display shows



MP3 / USB display

Note on CD-R/RW discs

- Because of non-standardized format definition/ production of CD-R/RW, playback quality and performance are not guaranteed.
- Manufacturer is not responsible for the playability of CD-R/RW due to recording conditions, such as PC performance, writing software, media ability, etc.
- Do not attach a seal or label to either side of the CD-R/RW disc. It may cause a malfunction.
- It is recommended to record only audio files on CD-R/RW discs for easy reading.

## FOLDER UP

For MP3/USB playback, when the unit is at STOP mode, skip up to next folder/album at increasing order, press PLAY/PAUSE button to start the playback of the selected folder/album.

When the unit is at MP3/USB PLAYBACK mode, skip up to next folder/album at increasing order, then it will start playback of the selected folder/album.



## USB OPERATION

1. Set to USB.
2. Connect USB disk or MP3 player into the USB port.
3. Press the STOP / CD / USB button and play automatically.

note: USB connector does not support connection with USB extension cable and it is not designed for communication with computer directly. Manufacturer is not responsible for the playability of USB disk or MP3 player due to recording condition, capacity, interface compatibility, etc.

Due to different formats, some USB disks or MP3 players may take longer time to be read.

**USB stick is direct connected or with a cable with max. 0.5 m length.**

### FUNCTION



Unit will be automatically off at about 15 mins without further operation (in stop mode).

After auto off, slide the FUNCTION selector to OFF position and then slide to USB position for listening.

## PROGRAMMED PLAYBACK

### PROGRAMMED PLAYBACK

#### FOR NORMAL COMPACT DISC PLAYBACK

Programmed playback enables tracks on a disc to be played in the desired order. Up to 20 tracks can be programmed.

1. Press the "PROGRAM" button.
2. Press the "NEXT" and "PREV" buttons to select the desired track number.
3. Press "PROGRAM" button again to memorize the track.
4. Repeat steps 2 and 3 until all desired tracks are programmed.
5. Press the "PLAY/PAUSE" button to start. "▶" & "PROG." are shown on the CD display.
6. Press the "STOP" button once to stop programmed playback.

7. Press the "PLAY/PAUSE" buttons to resume programmed playback.
8. Open the CD door or turn off the CD player or press "STOP" button twice to clear the programmed memory.

**Note** : Programming can only be made when the player is in stop mode.



CD display  
"PROGRAM"



GB 4





## FOR MP3 / USB PLAYBACK

Programmed playback enables tracks on a disc to be played in the desired order. Up to 20 tracks can be programmed.

1. Press the "PROGRAM" button.
2. Press the "FOLDER UP" buttons to select the desired folder.
3. Press the "NEXT ►►" and "PREV ◀◀" buttons to select the desired track number.
4. Press "PROGRAM" button again to memorize the selected track.
5. Repeat steps 2 to 4 until all desired tracks are programmed.
6. Press the "PLAY/PAUSE ►||" button to start. "►", "PROG." and "MP3" / "USB" are shown on the CD display.

7. Press "STOP ■" button once to stop programmed playback.
8. Press "PLAY/PAUSE ►||" button to resume programmed playback.
9. Open the CD door, turn off the CD player or press "STOP ■" button twice to clear the programmed memory.

**Note :** Programming can only be made when the player is in stop mode.



MP3 / USB display  
"PROGRAM"



## MAINTENANCE

### CLEANING CD

If the CD skips or will not play, the disc may need cleaning. Before playing, wipe the disc from the centre out with a cleaning cloth.

After playing, store the disc in its case.



### CLEANING THE CD LENS

If the CD lens is dusty, clean it with a brush-blower. Blow several times on the lens and remove the dust with the brush. Finger prints may be removed with a cotton swab moistened with alcohol.

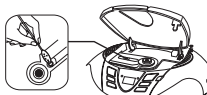

### CLEANING THE UNIT

Do not use volatile chemicals on this unit. Clean by lightly wiping with a soft cloth.

### IMPORTANT NOTE

If an abnormal display indication or an operating problem occurs, disconnect the AC power cord and remove the batteries. Wait at least 5 seconds, then reconnect the AC power cord or reinstall the batteries.

### WARNING

Should the CD door be opened before the reading of the CD is completed, a jamming noise may occur. This is resolved by closing the CD door.

## SPECIFICATIONS

### CD SECTION

Channels:

S / N ratio:

Wow & Flutter:

Sampling frequency:

Quantization:

Pick up light source:

Pick up wave length

2 channels

60 dB

undetectable

44.1 kHz 8 x over sampling

1 bit DA converter

Semi - conductor laser

790 nm

### RADIO SECTION

Tuning ranges:

Antennas:

FM 87.5 - 108 MHz

FM Rod antenna

### GENERAL

Output power:

Power consumption:

Speaker:

Power source:

1.2 W + 1.2 W (RMS)

11.5 W

3 " 8 OHM

AC : 230V ~ 50Hz

DC : 9V ( 6 x 1.5V LR14/ "C"/UM2 not included )

0°C to 40°C

259(L) x 223(D) x 125(H)mm

1.28 KGS

Operating temperature range:

Dimensions:

Weight

Due to continuing improvement, the features and the design are subject to change without notice.





### Guarantee

Lenco offers service and warranty in accordance with the European law, which means that in case of repairs (both during and after the warranty period) you should contact your local dealer.

**Important note:** It is not possible to send products that need repairs to Lenco directly.

**Important note:** If this unit is opened or accessed by a non-official service center in any way, the warranty expires.

This device is not suitable for professional use. In case of professional use, all warranty obligations of the manufacturer will be voided.

### Disclaimer

Updates to Firmware and/or hardware components are made regularly. Therefore some of the instruction, specifications and pictures in this documentation may differ slightly from your particular situation. All items described in this guide for illustration purposes only and may not apply to particular situation. No legal right or entitlements may be obtained from the description made in this manual.

### Disposal of the Old Device



This symbol indicates that the relevant electrical product or battery should not be disposed of as general household waste in Europe. To ensure the correct waste treatment of the product and battery, please dispose them in accordance to any applicable local laws of requirement for disposal of electrical equipment or batteries. In so doing, you will help to conserve natural resources and improve standards of environmental protection in treatment and disposal of electrical waste (Waste Electrical and Electronic Equipment Directive).

### Where to place the item :

Today's furniture is coated with a wide variety of lacquers and synthetic-coatings that are treated with an extensive range of cleaning products. Therefore, the possibility that some of these substances contain components that react adversely to the rubber feet of the item and soften them, cannot be completely excluded. The rubber feet of the appliance can cause discoloring to furniture surfaces. If necessary, place the appliance on a non-slide surface.

©All rights reserved

### Service

For more information and helpdesk support, please visit [www.lenco.com](http://www.lenco.com).

Lenco Benelux BV, Thermiekstraat 1a, 6361 HB, Nuth, The Netherlands

